

Micro LED

**Dimensions in millimeters (+ / - 0.1 mm)*

114" Micro LED Set Dimensions

	114"
SET(Without Optional Stand) (W * H2(H1) * D1)	2526.3*1434.2(1429.1)*24.9
SET(With Optional Stand) (W * H * D)	2526.3*1459.1*410.6
Front Opening Area (A * B * C)	2523.7*1426.5*2898.9
Wall Mount (VESA) (a * b)	1000*800
Packing Out (W * H * D)	2760*1776*770
Net Weight (With stand) Kg	99.0
Net Weight (Without stand) Kg	79.0
Gross Weight Kg	187.0

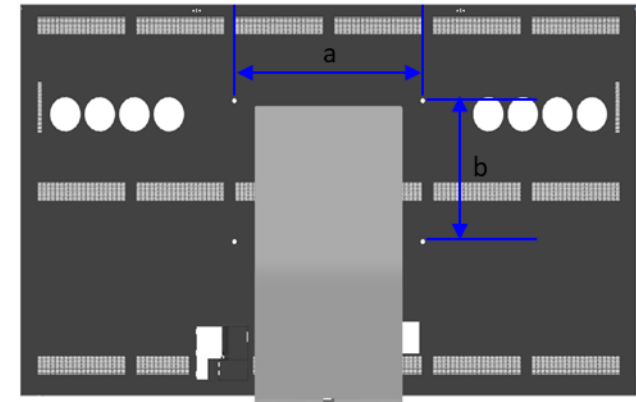
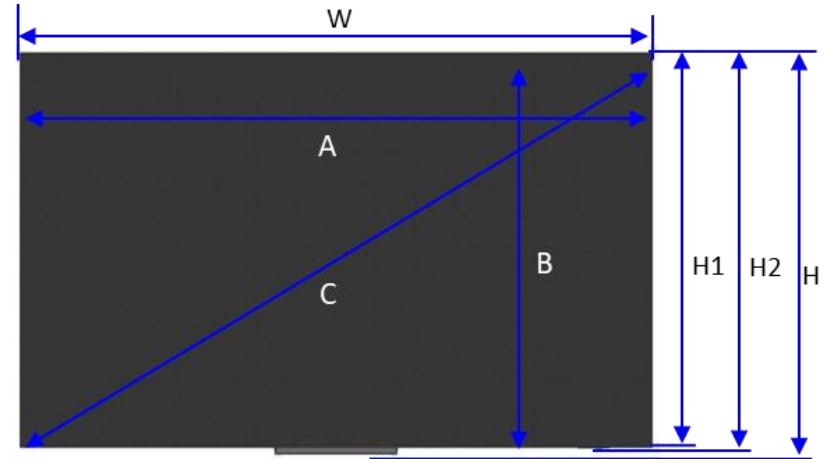

※ Height Type
 1) H : Includes Rubber-Foot
 2) H1 : Representative Dimension. Outermost dimension of Chassis-Front.
 3) H2 : Includes Logo

*Last updated 11/13/23

SAMSUNG IS NOT RESPONSIBLE FOR INACCURACIES. FOR CRITICAL INSTALLATIONS, IT IS STRONGLY RECOMMENDED TO CONFIRM ALL MEASUREMENTS BY USING AN ACTUAL SAMPLE MODEL INTENDED FOR A SPECIFIC INSTALLATION.

Micro LED

**Dimensions in millimeters (+ / - 0.1 mm)*

Micro LED Cover and Rear View Dimensions

	114"
WALL MOUNT(AXB)	1000*800
C	763.1
D	149.8
E	479.2

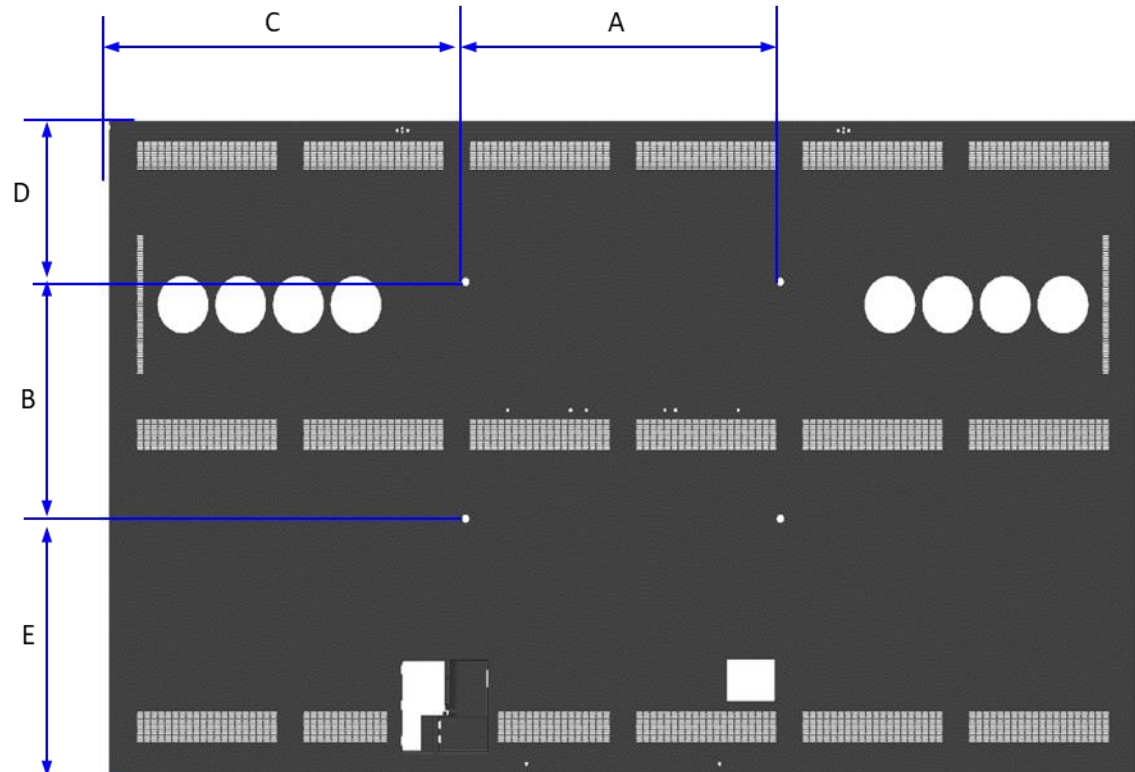

*Last updated 11/13/23

SAMSUNG IS NOT RESPONSIBLE FOR INACCURACIES. FOR CRITICAL INSTALLATIONS, IT IS STRONGLY RECOMMENDED TO CONFIRM ALL MEASUREMENTS BY USING AN ACTUAL SAMPLE MODEL INTENDED FOR A SPECIFIC INSTALLATION.

Micro LED

**Dimensions in millimeters (+ / - 0.1 mm)*

114" Micro LED Cover and Rear-View Dimension

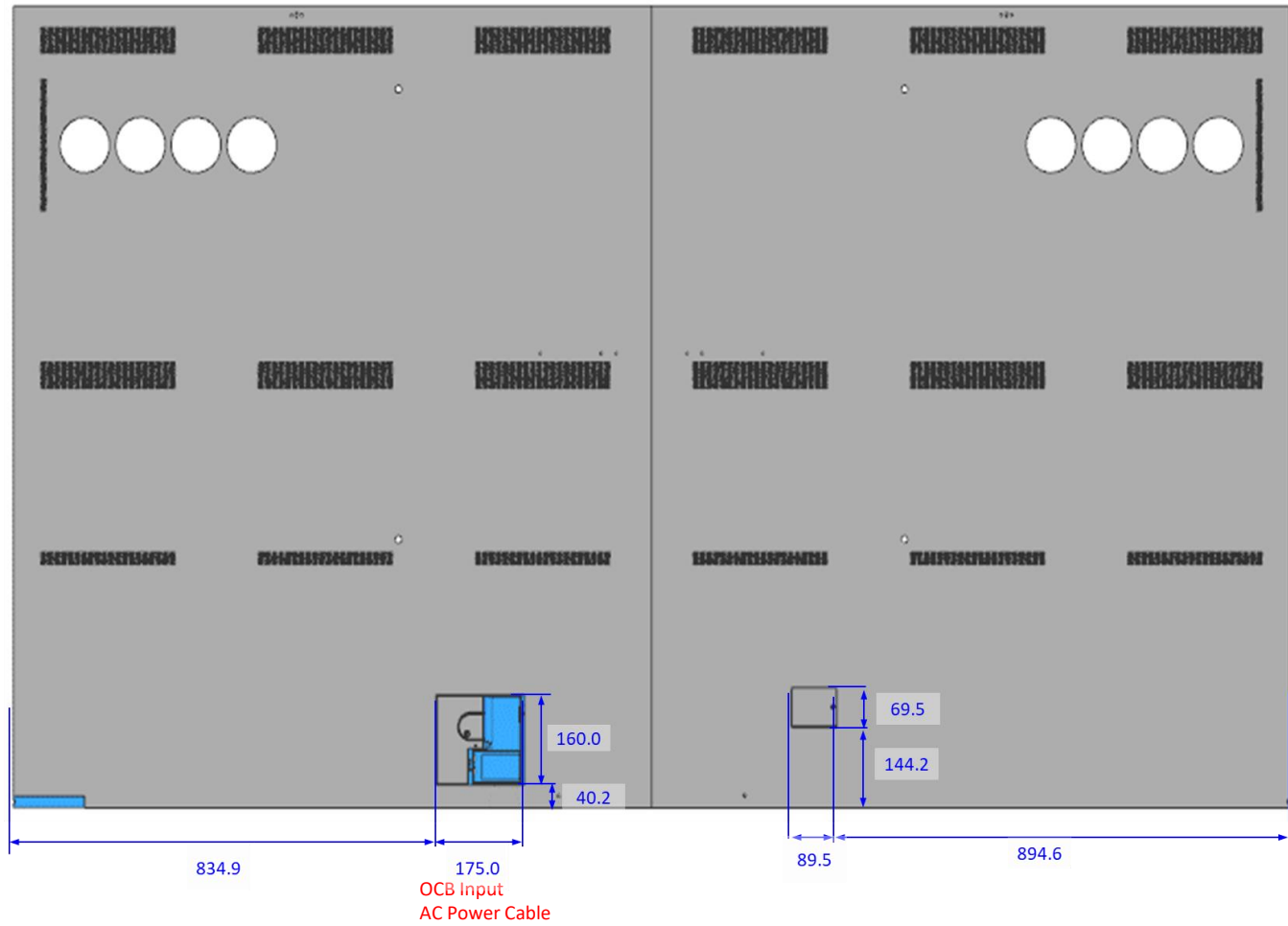

*Last updated 11/13/23

SAMSUNG IS NOT RESPONSIBLE FOR INACCURACIES. FOR CRITICAL INSTALLATIONS, IT IS STRONGLY RECOMMENDED TO CONFIRM ALL MEASUREMENTS BY USING AN ACTUAL SAMPLE MODEL INTENDED FOR A SPECIFIC INSTALLATION.

Micro LED

**Dimensions in millimeters (+ / - 0.1 mm)*

Micro LED Bezel Size

	114"
A (Top/Bottom/ Left/Right)	0.8
B (Top/Bottom/ Left/Right)	24.9

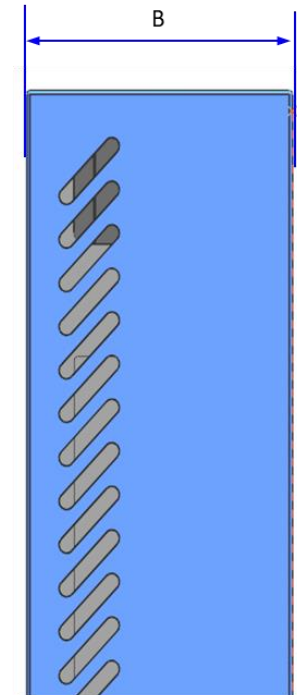
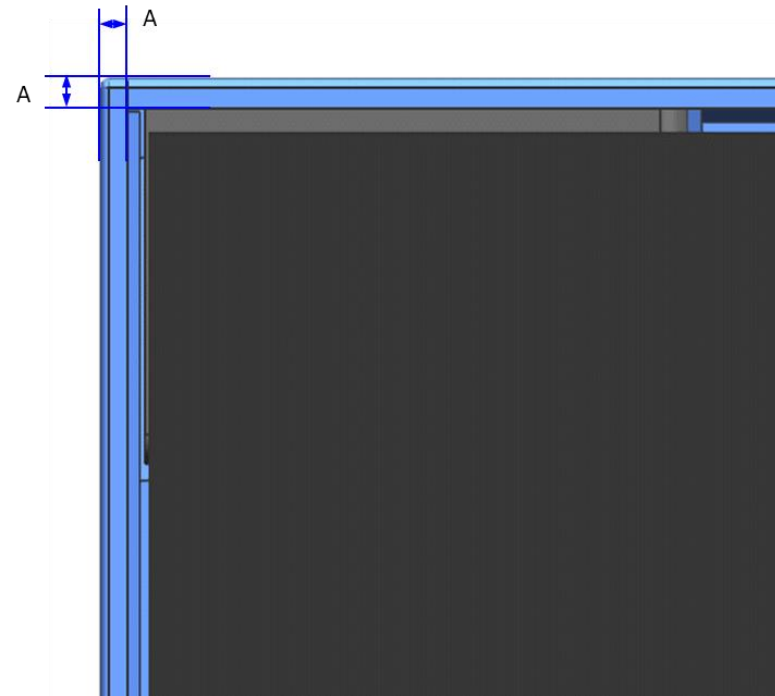

*Last updated 11/13/23

*SAMSUNG IS NOT RESPONSIBLE FOR INACCURACIES. FOR CRITICAL INSTALLATIONS,
IT IS STRONGLY RECOMMENDED TO CONFIRM ALL MEASUREMENTS BY USING AN ACTUAL SAMPLE MODEL INTENDED FOR A SPECIFIC INSTALLATION.*

Micro LED

**Dimensions in millimeters (+ / - 0.1 mm)*

Wall Mount and Depth

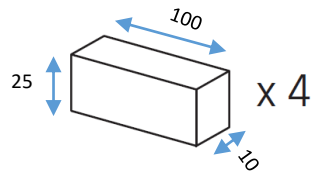
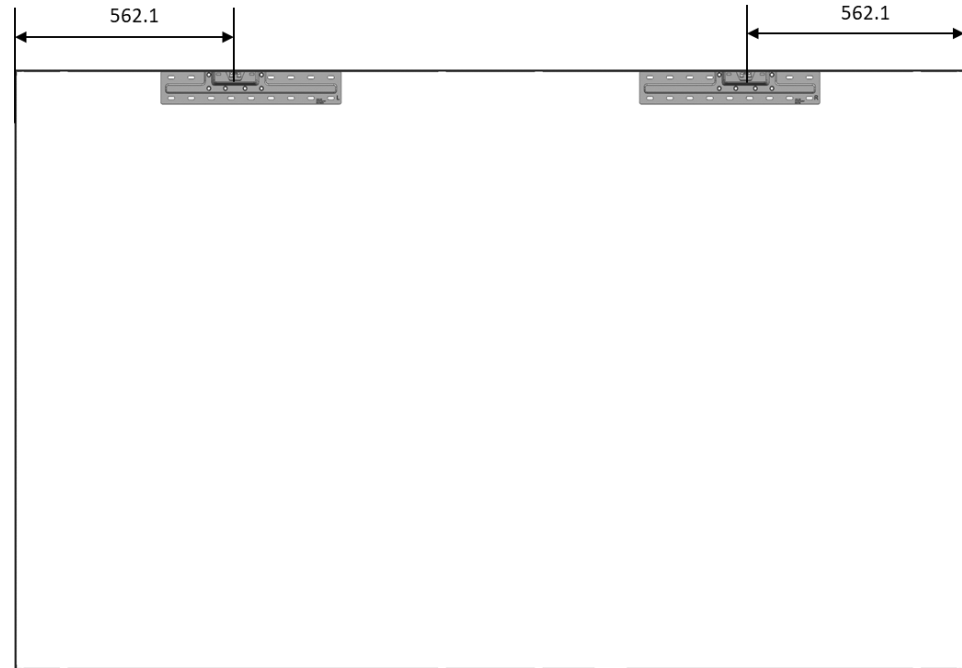
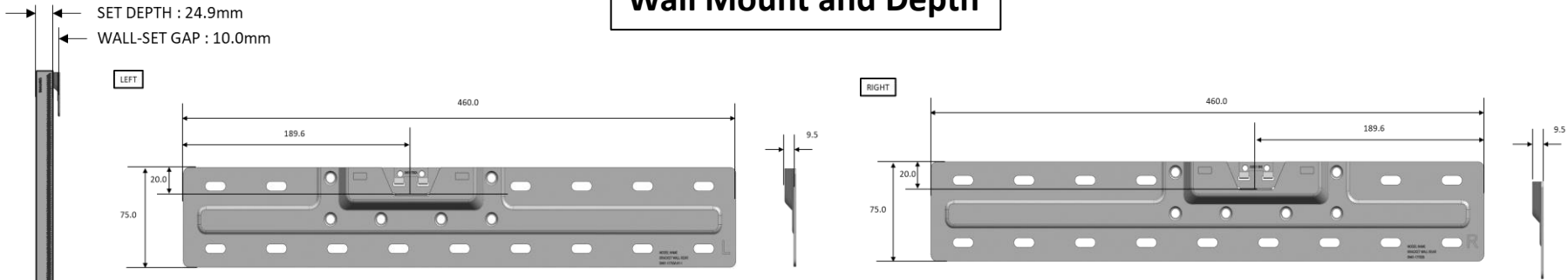

Foam Spacers (mm)

*Last updated 11/13/23

SAMSUNG IS NOT RESPONSIBLE FOR INACCURACIES. FOR CRITICAL INSTALLATIONS, IT IS STRONGLY RECOMMENDED TO CONFIRM ALL MEASUREMENTS BY USING AN ACTUAL SAMPLE MODEL INTENDED FOR A SPECIFIC INSTALLATION.

Micro LED

**Dimensions in millimeters (+ / - 0.1 mm)*

Micro LED Stand: VG-SMSA20MC/ZA Dimensions

	114"
STAND (W*H*D)	471.0*849.0*410.6

**Optional
Accessory
*Sold
Separately**

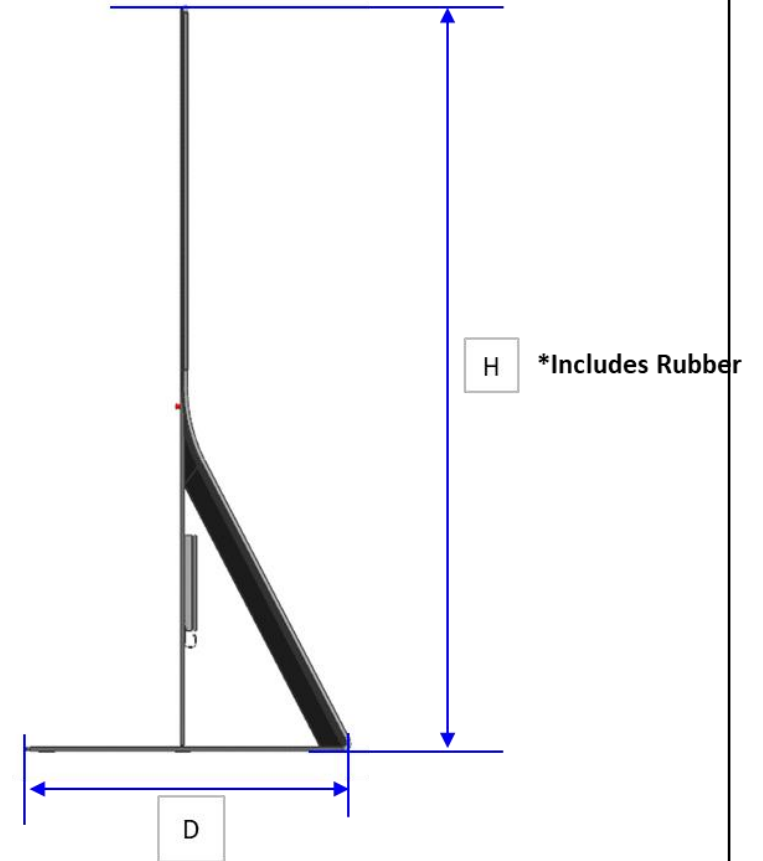
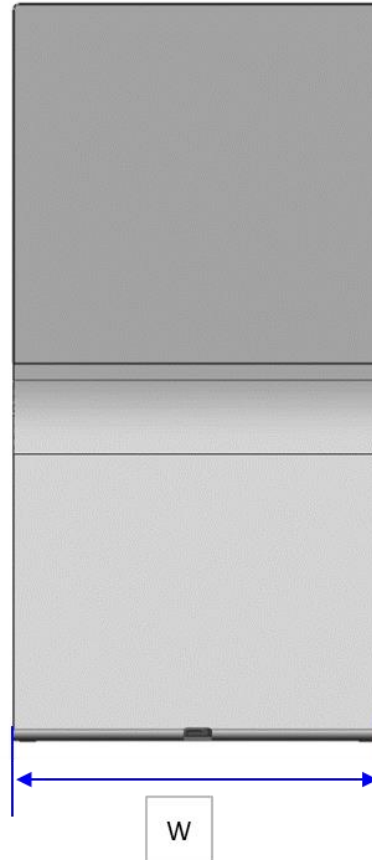

*Last updated 11/13/23

SAMSUNG IS NOT RESPONSIBLE FOR INACCURACIES. FOR CRITICAL INSTALLATIONS,
IT IS STRONGLY RECOMMENDED TO CONFIRM ALL MEASUREMENTS BY USING AN ACTUAL SAMPLE MODEL INTENDED FOR A SPECIFIC INSTALLATION.

Micro LED

**Dimensions in millimeters (+ / - 0.1 mm)*

Micro LED OC Box Dimensions

W * D * H	361.5 * 124.5 * 33.8
Net Weight (kg)	1.1

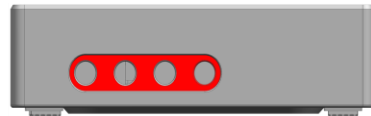
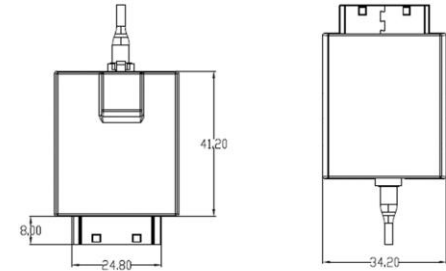
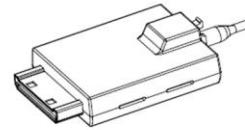

H = INCLUDE RUBBER FOOT

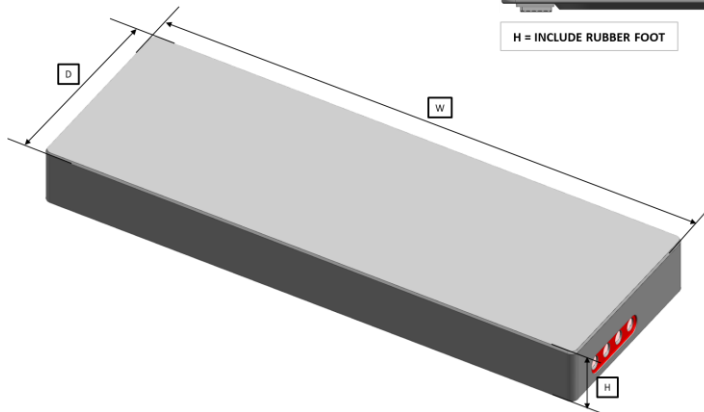

Length: 5M

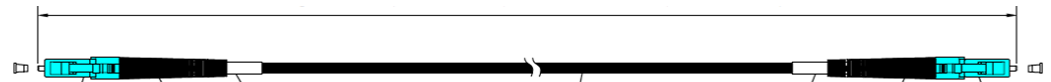

*Last updated 11/13/23

SAMSUNG IS NOT RESPONSIBLE FOR INACCURACIES. FOR CRITICAL INSTALLATIONS, IT IS STRONGLY RECOMMENDED TO CONFIRM ALL MEASUREMENTS BY USING AN ACTUAL SAMPLE MODEL INTENDED FOR A SPECIFIC INSTALLATION.

Micro LED

**Dimensions in millimeters (+ / - 0.1 mm)*

Micro LED IR Sensor Location

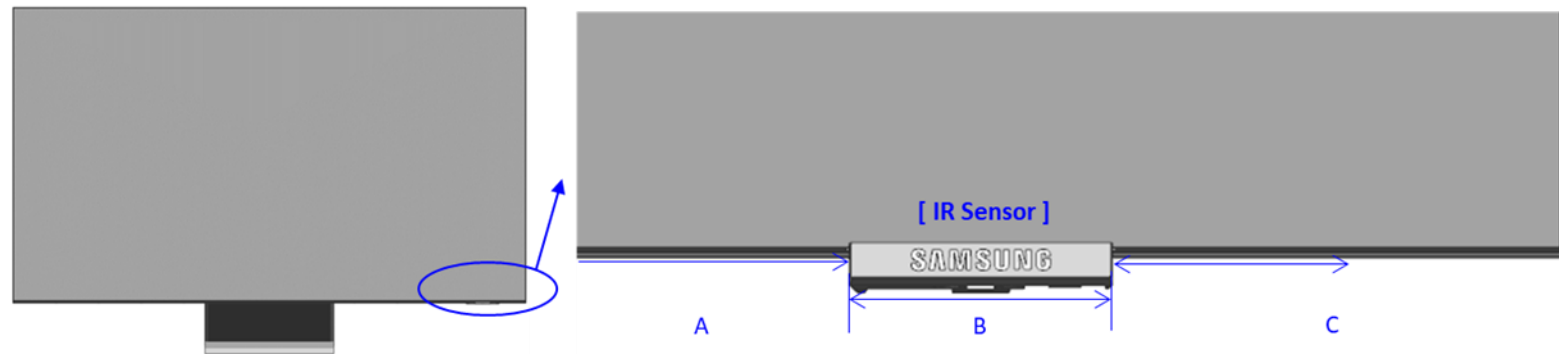

Product	Series	Inch	Item	Sensor Position	DIMENSION		
					A	B	C
Micro LED	MS1C	114	MNA114MS1C	Right	2448.7	24.7	53

*Last updated 11/13/23

SAMSUNG IS NOT RESPONSIBLE FOR INACCURACIES. FOR CRITICAL INSTALLATIONS, IT IS STRONGLY RECOMMENDED TO CONFIRM ALL MEASUREMENTS BY USING AN ACTUAL SAMPLE MODEL INTENDED FOR A SPECIFIC INSTALLATION.